

SKF 53315参数

主要尺寸	d	75	mm	-
	D	135	mm	-
	H ₁	52	mm	-
基本额定载荷	C	163000	N	动载荷
	C ₀	390000	N	静载荷
疲劳载荷极限	P _u	14000	N	-
最小载荷系数	A	0.79	-	-
额定转速	额定转度	1700	r/min	-
	极限转速	2400	r/min	-
重量	轴承+垫圈	3200	g	-
型号	轴承	53315	-	-
	座圈	U 315	-	-

SKF 53315图片

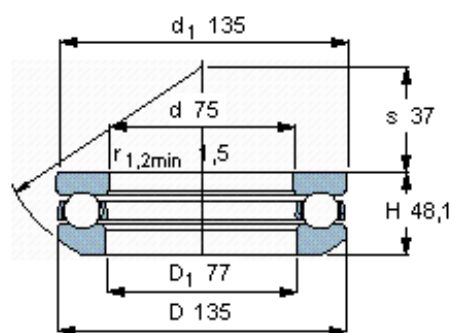

垫圈的球面曲率半径

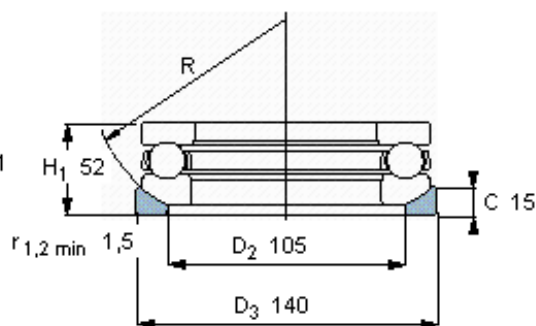

R 100

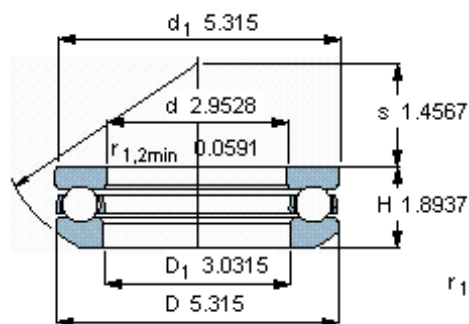
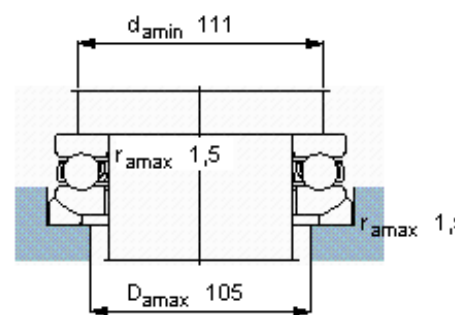

垫圈的球面曲率半径

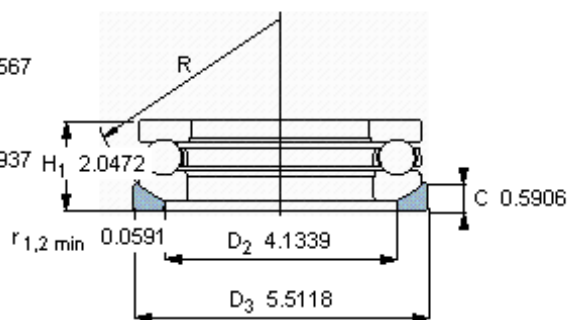

R 3.937

