

SKF 53202参数

主要尺寸	d	15	mm	-
	D	32	mm	-
	H ₁	15	mm	-
基本额定载荷	C	16500	N	动载荷
	C ₀	27000	N	静载荷
疲劳载荷极限	P _u	1000	N	-
最小载荷系数	A	0.004	-	-
额定转速	额定转度	7000	r/min	-
	极限转速	10000	r/min	-
重量	轴承+垫圈	63	g	-
型号	轴承	53202	-	-
	座圈	U 202	-	-

SKF 53202图片

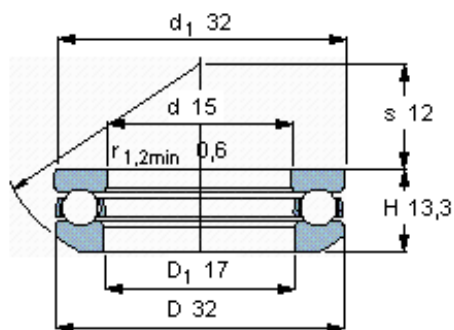

垫圈的球面曲率半径

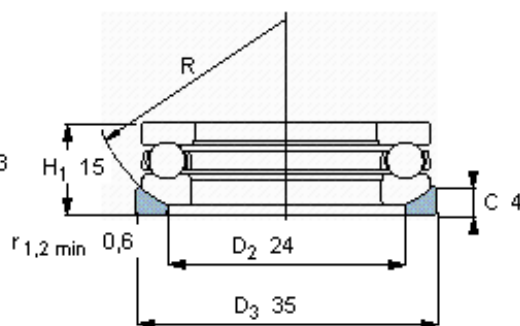

R 28

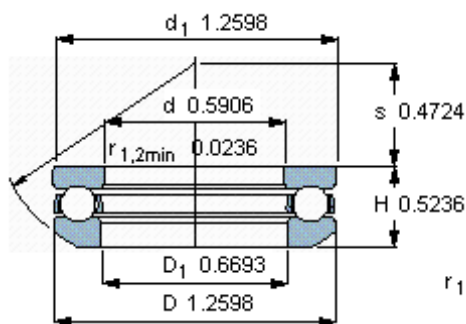
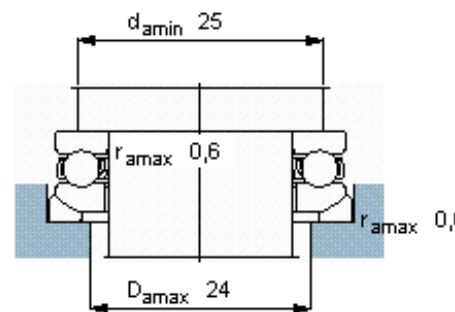

垫圈的球面曲率半径

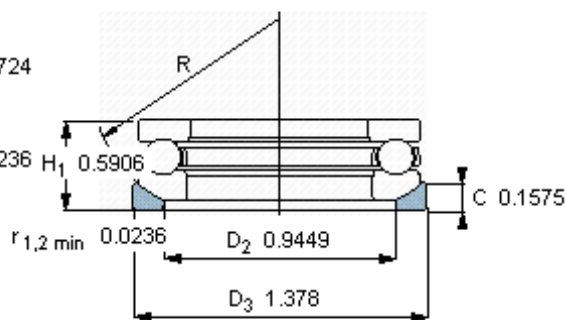

R 1.1024

