

SKF QJ 207 N2MA *参数

主要尺寸	d	35	mm	-
	D	72	mm	-
	B	17	mm	-
基本额定载荷	C	49000	N	动载荷
	C_0	41500	N	静载荷
疲劳载荷极限	P_u	1760	N	-
额定转速	参考转速	12000	r/min	-
	极限转速	17000	r/min	-
重量	重量	360	g	-
型号	* SKF 探索者轴承	QJ 207 N2MA *	-	-

SKF QJ 207 N2MA *图片

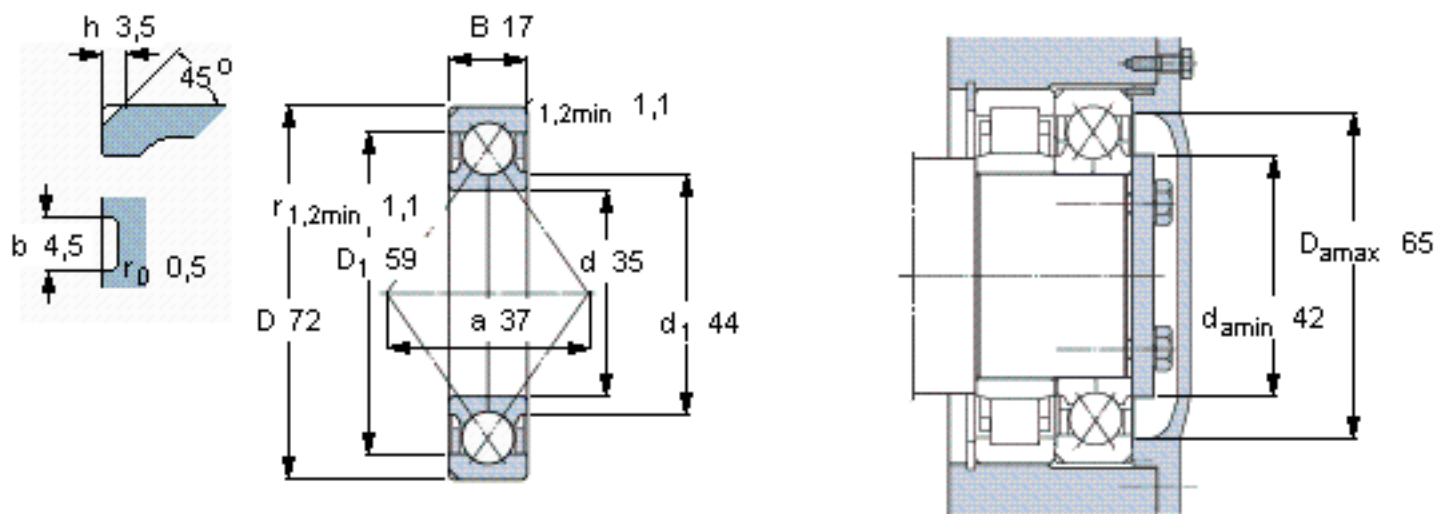

计算系数

- k_a 1
- e 0,95
- X 0,6
- Y_1 0,66
- Y_2 1,07
- Y_0 0,58

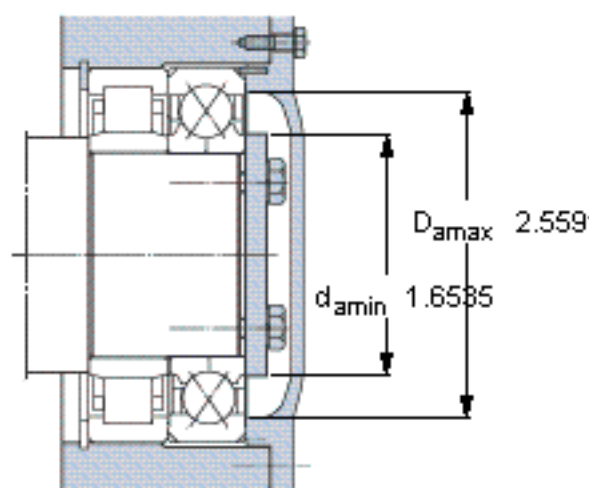
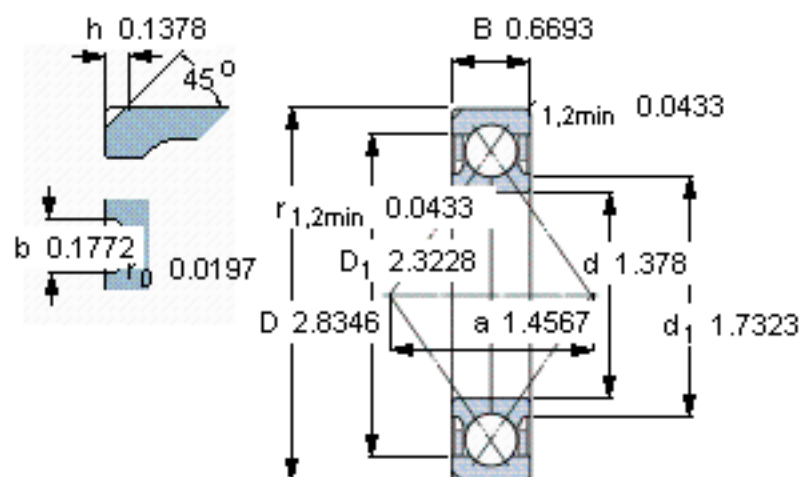

计算系数

$k_a = 1$

$e = 0,95$

$X = 0,6$

$Y_1 = 0,66$

$Y_2 = 1,07$

$Y_0 = 0,58$