

TIMKEN 140RU91参数

轴承型号	Part Number	140RU91		-
	Subtype	NU		-
尺寸	d	140	mm	内径
	D	220	mm	外径
	B	63.5	mm	宽度
额定载荷	C1	582717	N	一百万转动态径向载荷
	C0	787335	N	静态额定载荷
几何结构系数	Cg	0.1608		几何系数
极限转速	oil	3500		润滑油
	grease	2700		润滑脂
尺寸	R	2.032	mm	最大轴肩倒角半径
	da	153.924	mm	轴肩直径
	r	2.032	mm	最大轴承座挡肩圆角半径
	Da	206.248	mm	轴承座挡肩直径
重量	Assembly Weight	9321.32	g	-

TIMKEN 140RU91图片

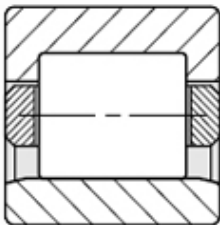
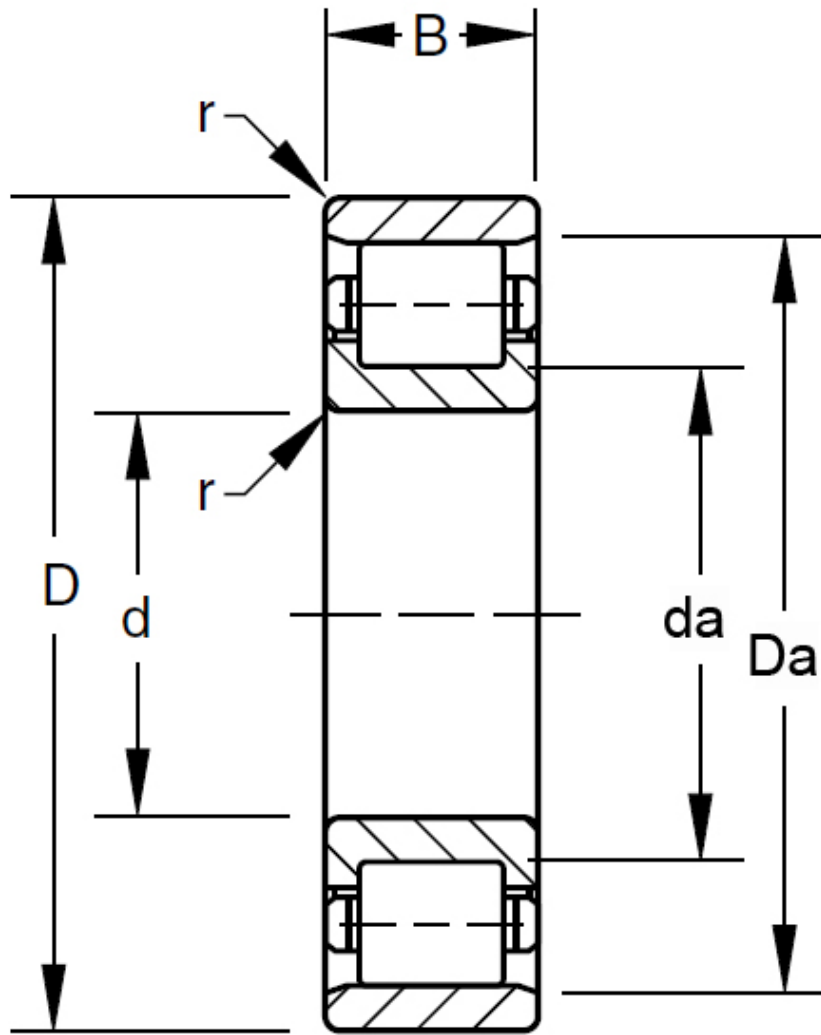

RU
RIU

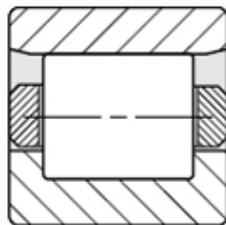

RN
RIN

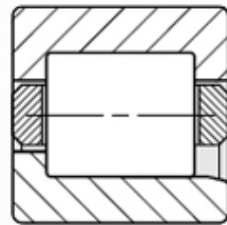

RJ
RIJ

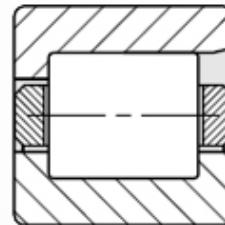

RF
RIF

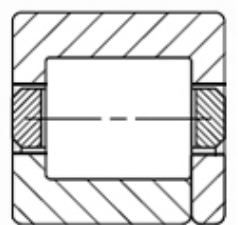

RT
RIT

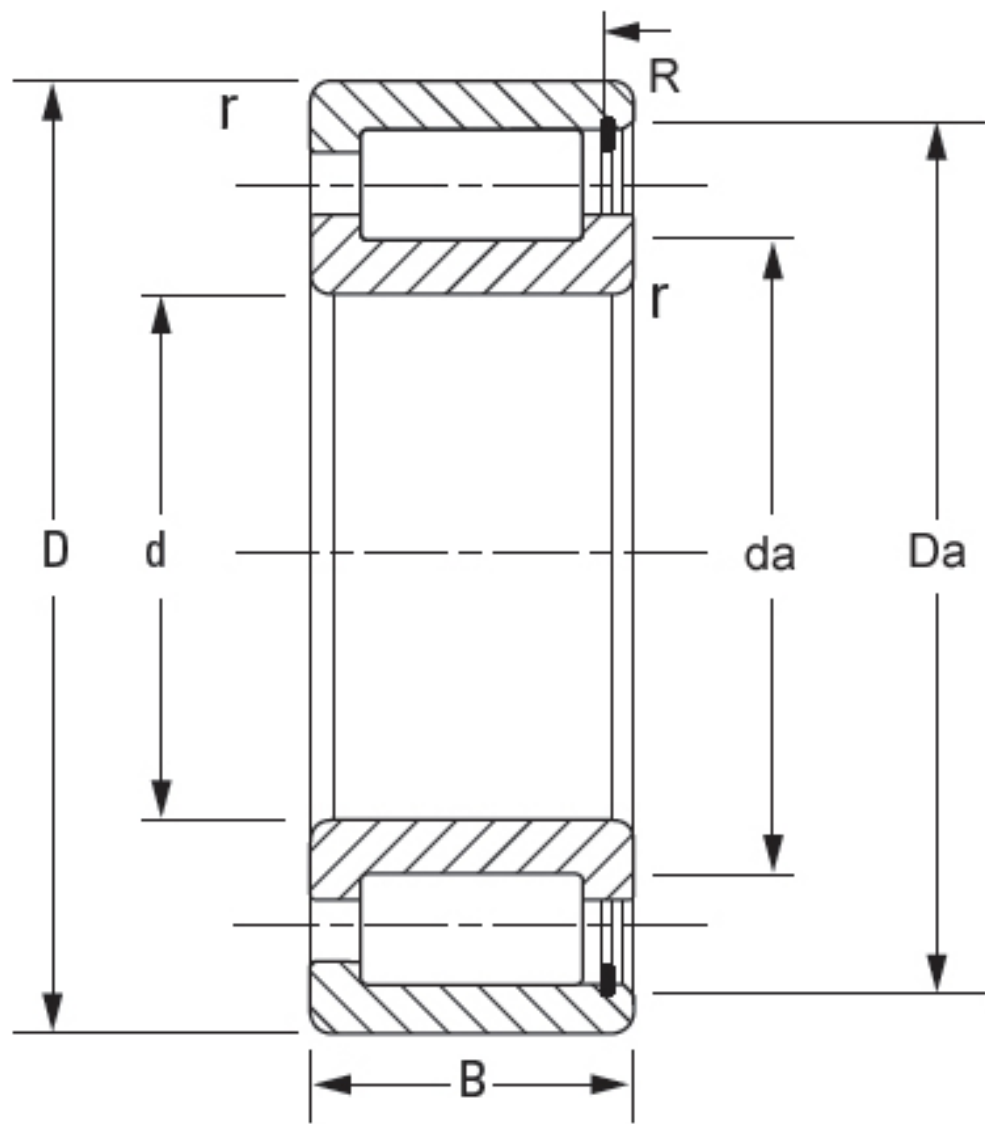

NCF