

SKF S71918 CD/HCP4A参数

主要尺寸	d	90	mm	-
	D	125	mm	-
	B	18	mm	-
基本额定载荷	C	47500	N	动载荷
	C_0	51000	N	静载荷
疲劳载荷极限	P_u	2080	N	-
可达转速	Grease	13000	r/min	-
	Oil-air	-	r/min	-
重量	重量	480	g	-
型号	型号	S71918 CD/HCP4A	-	-

SKF S71918 CD/HCP4A图片

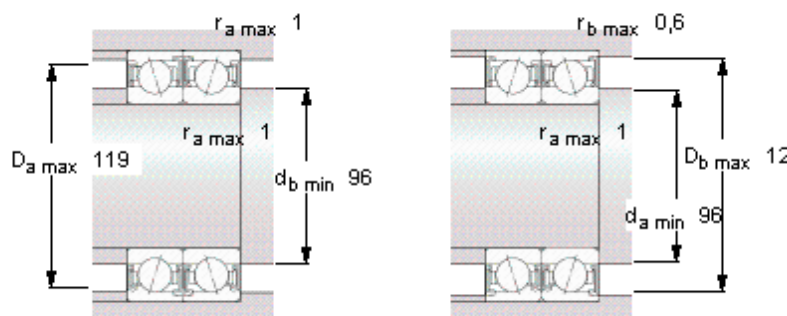
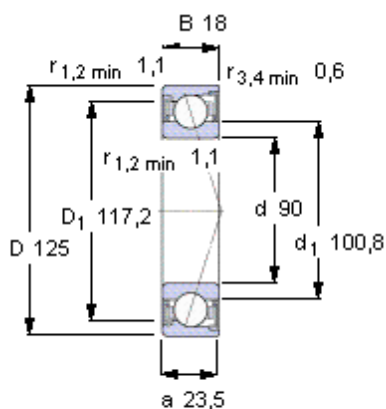

Ball diameter 11,112

Number of balls 26

未安装时的预载荷 [N]

背对背配置，面对面配置

预载荷等级

A	B	C	D
180	360	720	1440

Static axial stiffness [N/μm]

(guideline value)

预载荷等级

A	B	C	D
104	143	203	297

Reference grease quantity [cm³]

G_{ref} -

计算系数

for equivalent bearing load

f_0 16,3

for preload in mounted bearing sets

f 1,23

f_1 1

f_{2A} 1

f_{2B} 1,07

f_{2C} 1,12

f_{2D} 1,18

f_{HC} 1,04

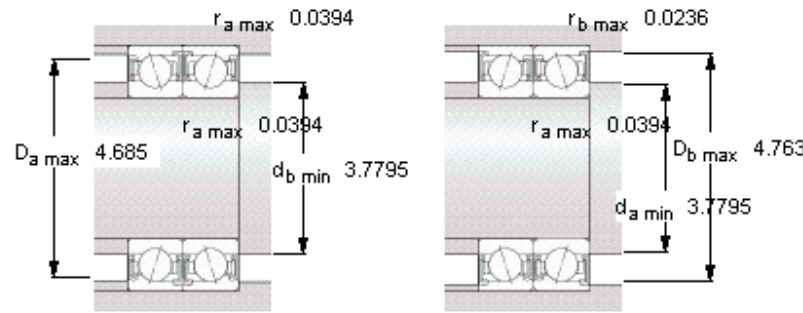
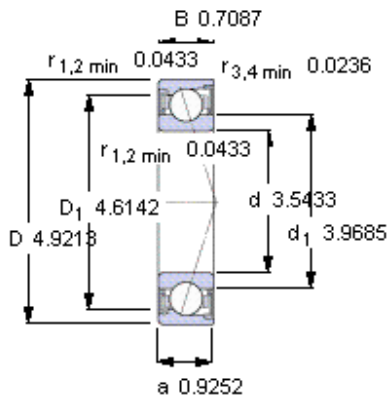

Ball diameter 11,112

Number of balls 26

未安装时的预载荷 [N]

背对背配置，面对面配置

预载荷等级

A	B	C	D
180	360	720	1440

Static axial stiffness [N/μm]

(guideline value)

预载荷等级

A	B	C	D
104	143	203	297

Reference grease quantity [cm³]

G_{ref} -

计算系数

for equivalent bearing load

f₀ 16,3

for preload in mounted bearing sets

f 1,23

f₁ 1

f_{2A} 1

f_{2B} 1,07

f_{2C} 1,12

f_{2D} 1,18

f_{HC} 1,04