

SKF 81160 M参数

主要尺寸	d	300	mm	-
	D	380	mm	-
	H	62	mm	-
基本额定载荷	C	850000	N	动载荷
	C_0	4400000	N	静载荷
疲劳载荷极限	P_u	335000	N	-
最小载荷系数	A	1.5	-	-
额定转速	额定转度	430	r/min	-
	极限转速	850	r/min	-
重量	重量	16500	g	-
型号	完整轴承	81160 M	-	-
	滚子和保持架推力组件	K 81160 M	-	-

SKF 81160 M图片

完整轴承

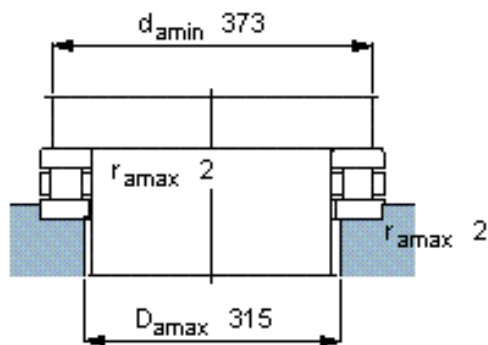
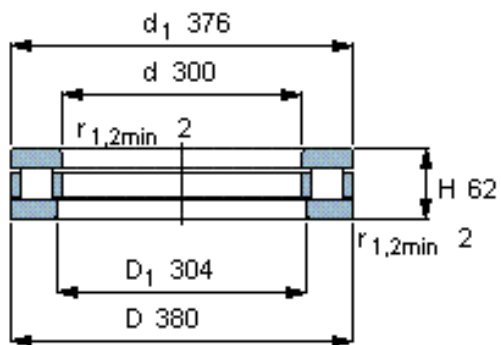

滚子和保持架推力组件

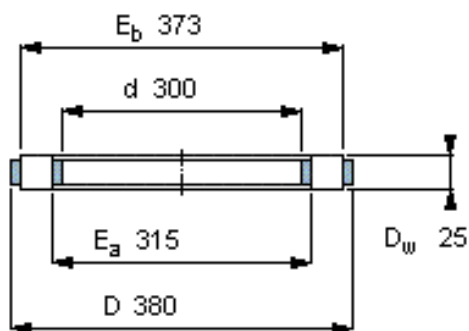

适宜的部件

轴垫圈
WS 81160

轴承座垫圈
GS 81160

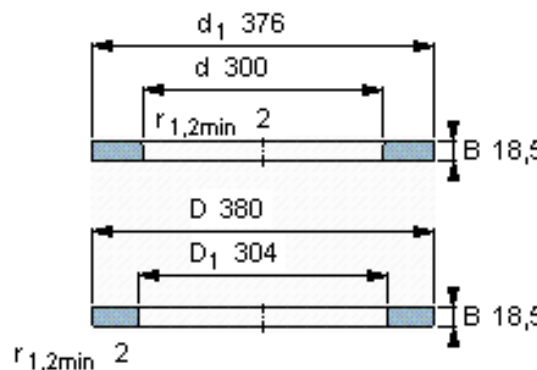

K 81160 M

质量 kg 4,51

完整轴承

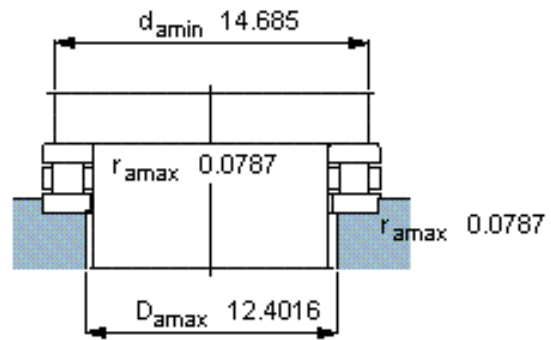
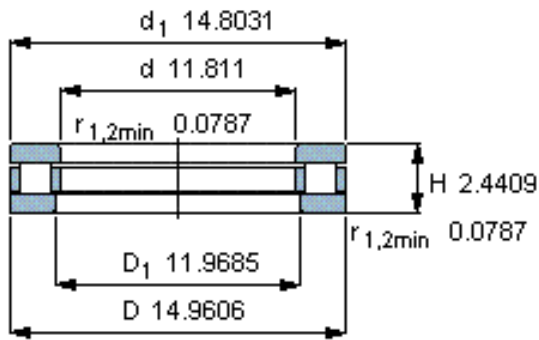

滚子和保持架推力组件

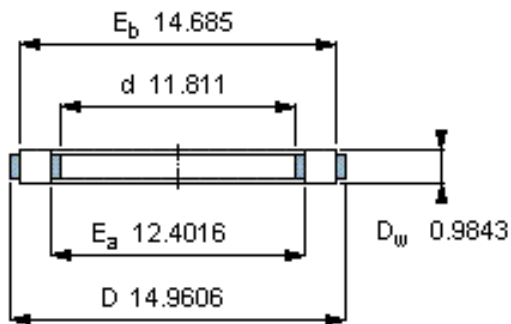

K 81160 M

质量 kg 4,51

适宜的部件

轴垫圈
WS 81160

轴承座垫圈
GS 81160

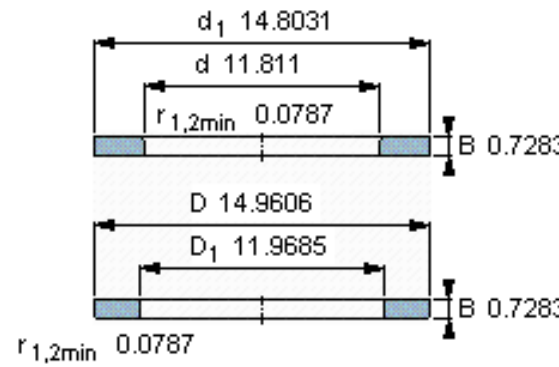

参考资料: <http://www.sozhou.com/p/609ae76d.html>