

SKF 81210 TN参数

主要尺寸	d	50	mm	-
	D	78	mm	-
	H	22	mm	-
基本额定载荷	C	91500	N	动载荷
	C_0	300000	N	静载荷
疲劳载荷极限	P_u	31000	N	-
最小载荷系数	A	0.007	-	-
额定转速	额定转度	1700	r/min	-
	极限转速	3400	r/min	-
重量	重量	360	g	-
型号	完整轴承	81210 TN	-	-
	滚子和保持架推力组件	K 81210 TN	-	-

SKF 81210 TN图片

完整轴承

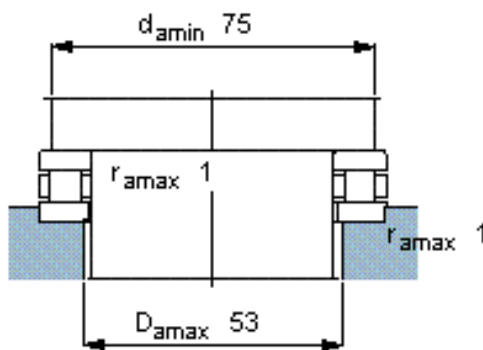
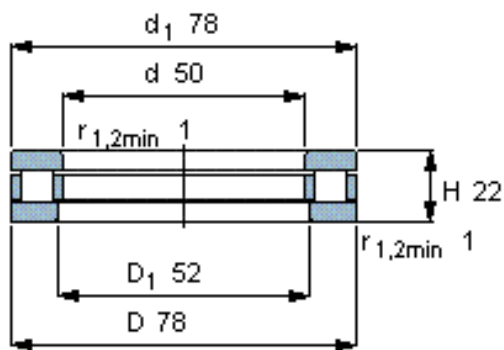

滚子和保持架推力组件

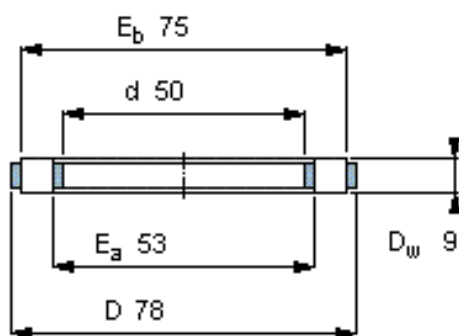

K 81210 TN

质量 kg 0,08

适宜的部件

轴垫圈
WS 81210

轴承座垫圈
GS 81210

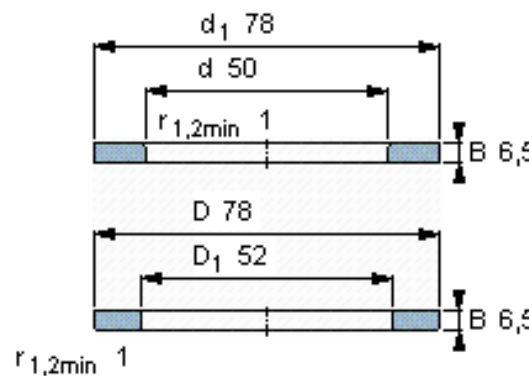

完整轴承

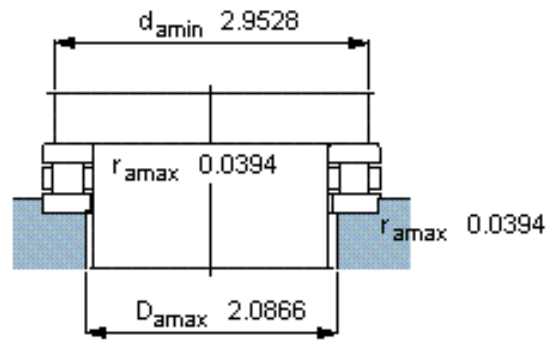
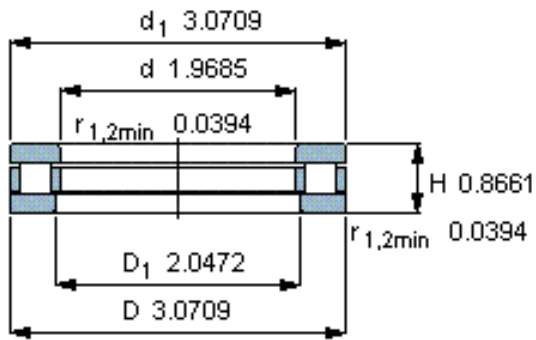

滚子和保持架推力组件

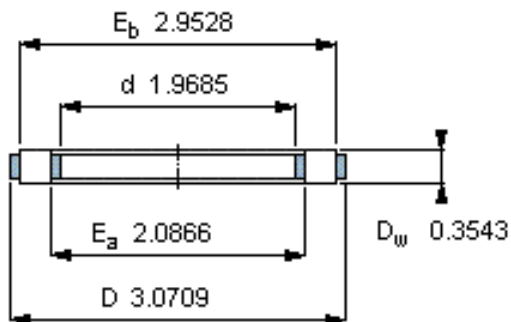

K 81210 TN

质量 kg 0,08

适宜的部件

轴垫圈
WS 81210

轴承座垫圈
GS 81210

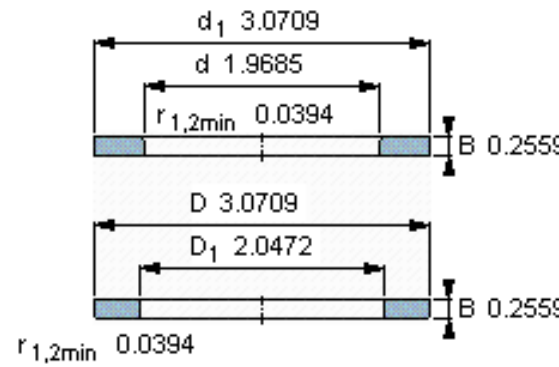

参考资料: <http://www.sozhou.com/p/52cee0d9.html>