

SKF 53318参数

主要尺寸	d	90	mm	-
	D	155	mm	-
	H ₁	59	mm	-
基本额定载荷	C	195000	N	动载荷
	C ₀	500000	N	静载荷
疲劳载荷极限	P _u	16600	N	-
最小载荷系数	A	1.3	-	-
额定转速	额定转度	1500	r/min	-
	极限转速	2200	r/min	-
重量	轴承+垫圈	4700	g	-
型号	轴承	53318	-	-
	座圈	U 318	-	-

SKF 53318图片

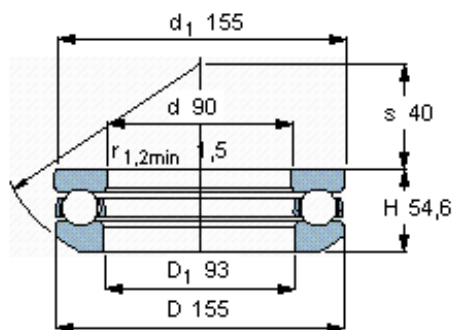

垫圈的球面曲率半径

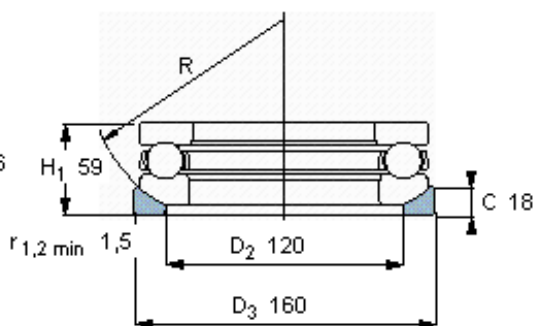

R 112

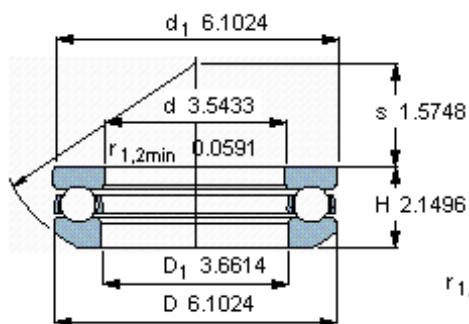
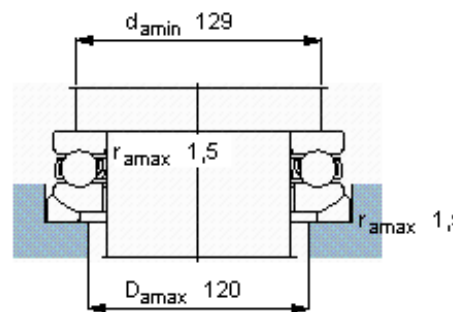

垫圈的球面曲率半径

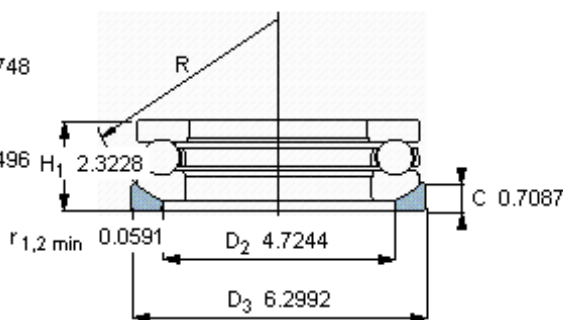

R 4.4094

