

KOYO 7406B参数

主要尺寸	SD	30	mm	内径
	D	90	mm	外径
	B	23	mm	宽度
	R	1.5	mm	(最小)
型号	ORDER	7406B		型号
基本额定载荷	C	47400	N	动载荷
	C0	29300	N	静载荷
极限转速	NG	5200	1/min	脂润滑
	NO	7100	1/min	油润滑

KOYO 7406B图片

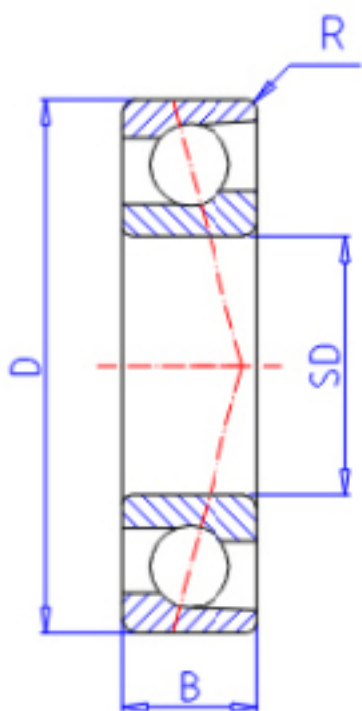

参考资料:<http://www.sozhou.com/p/39e43898.html>

